

# INSTALLATION AND OPERATION MANUAL

# KBWA SERIES

## HYBRID DRIVE™

### Digital Drive with Analog Interface

KBWA-23D: NEMA 1 / IP20 (Vented) Enclosure

KBWA-22D, 21D, 2P6D, 2P3D: NEMA 1 / IP50 (Non Vented) Enclosure

Rated for 208 – 230 Volt 50 and 60 Hz  
Subfractional thru 1/2 HP 3-Phase AC and PSC\* Induction Motors

Operates from 115 and 208/230 Volt 50/60 Hz AC Line Input

Variable Speed / Soft Start  
with Electronic Motor Overload Protection

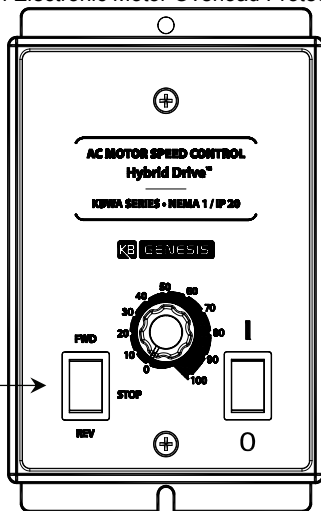

Designed and  
Assembled in USA

Provision for  
Forward-Stop-Reverse  
Switch (supplied).  
(See Sec. 6, on p. 18)

\*Operation with  
PSC Motors requires  
factory programming.

This Manual Covers Models KBWA-23D, 22D, 21D, 2P6D, 2P3D



SEE  
SAFETY WARNING  
ON PAGE 2

#### IMPORTANT

**AC Line Input Voltage Setting:** The drive is factory set for 208/230 Volt AC Line input. For 115 Volt AC Line input, see Section 7.1, on page 19.

**Motor Frequency Setting:** The drive is factory set for 60 Hz Motors. For 50 Hz Motors, see Section 4.1, on page 13.



Automation and Control

Copyright © 2014  
KB Electronics, Inc.  
(see back cover)

## SAFETY WARNING

### Definition of Safety Warning Symbols



**Electrical Hazard Warning Symbol:** Failure to observe this warning could result in electrical shock or electrocution.



**Operational Hazard Warning Symbol:** Failure to observe this warning could result in serious injury or death.



This product must be installed and serviced by a qualified technician, electrician, or electrical maintenance person familiar with its operation and the hazards involved. Proper installation, which includes electrical connections, fusing or other current protection, and grounding, can reduce the chance of electrical shocks, and/or fires, in this product or products used with this product, such as electric motors, switches, coils, solenoids, and/or relays. Do not use this drive in an explosion-proof application. Eye protection must be worn and insulated adjustment tools must be used when working with drive under power. This product is constructed of materials (plastics, metals, carbon, silicon, etc.) which may be a potential hazard. Proper shielding, grounding, and filtering of this product can reduce the emission of radio frequency interference (RFI) which may adversely affect sensitive electronic equipment. It is the responsibility of the equipment manufacturer and individual installer to supply this Safety Warning to the ultimate end user of this product. (SW 8/2012)

The drive contains electronic Start/Stop circuits, which can be used to start and stop the drive. However, these circuits are never to be used as safety disconnects since they are not fail-safe. Use only the AC Line for this purpose.

Be sure to read and follow all instructions carefully. Fire and/or electrocution can result due to improper use of this product.

**KBWA-23D:** NEMA 1 / IP20 (Vented) Enclosure

**KBWA-22D, 21D, 2P6D, 2P3D:** NEMA 1 / IP50 (Non Vented) Enclosure

### ITEMS INCLUDED IN THIS PACKAGE

Description	Part No.
Drive	—
Installation and Operation Manual	A40179
Accessories Bag: Jumper Wire for J3 (to Set the Drive for 115 Volt AC Line Input), Trimpot Adjustment Tool, Extra 6-32 X 3/8" Cover Screw, Status Indicators Label, and two Universal Bushings.	F36869
Switch Kit Bag: Forward-Stop-Reverse Switch Assembly, Two Wire Ties, and Installation Instructions.	F36868
Mounting Template	A42326
Warranty Registration Card	A40101

### QUICK-START INSTRUCTIONS

- 1. REMOVE THE COVER:** The cover must be removed to setup and wire the drive. See Section 5.1, on pages 16 and 17.
- 2. AC LINE INPUT SELECTION:** The drive is factory set for 208/230 Volt AC Line input (Jumper J3 not installed). Install the supplied jumper to set the drive for 115 Volt AC Line input. See Section 7.1, on page 19.
- 3. MOTOR FREQUENCY SELECTION:** Jumpers J1 and J2 are both factory set for 60 Hz motors. For other motors, see Section 7.2, on pages 19 – 21.
- 4. START MODE SELECTION:** The drive is factory set for Automatic Start Mode (jumper installed onto CON1). To operate the drive in the Manual Start Mode, the supplied Forward-Stop-Reverse Switch must be installed. See Section 7.3, on pages 21 and 22.
- 5. FORWARD/REVERSE SPEED SELECTION:** The drive is factory set for Forward Speed Operation (CON1 jumper installed in the "F" position). For Reverse Speed Operation, set the CON1 jumper in the "R" position. See Section 7.4, on page 22.  
**Note:** As an alternate to using the F-S-R jumper, reverse any two motor leads (with the AC Line disconnected and the motor stopped).
- 6. ADJUSTABLE TRIMPOTS:** All trimpots have been factory set for most applications. See Section 12, on pages 28 – 31.
- 7. MOUNTING THE DRIVE:** See Section 8, on page 23.
- 8. AC LINE INPUT, MOTOR AND GROUND CONNECTIONS:** At Terminal Block TB1, wire the AC Line input to "L1 and "L2"; the ground wire(s) to "GND"; and the motor to "U", "V", and "W". See Section 10, on pages 24 – 26.
- 9. FORWARD-STOP-REVERSE SWITCH (SUPPLIED):** Install the switch, if required. See Section 6, on page 18.
- 10. INSTALL THE COVER:** After the drive has been setup, mounted, and wired, install the cover. See Section 5.2, on page 17.



This product complies with all CE directives pertinent at the time of manufacture. Contact our Sales Department for Declaration of Conformity. Installation of a CE approved RFI filter is required. Additional shielded cable and/or AC Line cables may be required.

**Note:** *In order for this drive to meet CE requirements, a separate CE approved filter must be installed.*

### UL NOTICE

**115 Volt Drives:** Suitable for use on a circuit capable of delivering not more than 5 kA RMS symmetrical Amperes. 115 Volts maximum. Use copper conductors rated 75 °C. Suitable for operation in a maximum surrounding air temperature of 40 °C.

**230 Volt Drives:** Suitable for use on a circuit capable of delivering not more than 5 kA RMS symmetrical Amperes. 230 Volts maximum. Use copper conductors rated 75 °C. Suitable for operation in a maximum surrounding air temperature of 40 °C.

---

**TABLE OF CONTENTS**

---

<b>Section</b>	<b>Page</b>
1 FAMILIARIZING YOURSELF WITH THE DRIVE .....	7
2 ELECTRICAL RATINGS AND SPECIFICATIONS .....	9
3 INTRODUCTION .....	10
3.1 Standard Features .....	11
3.2 Performance Features .....	11
3.3 Protection Features .....	12
3.4 Selectable Jumpers .....	12
3.5 Adjustable Trimpots .....	12
3.6 Customization for OEMs .....	13
4 IMPORTANT APPLICATION INFORMATION .....	13
4.1 50 Hz Motors .....	13
4.2 Motor Current Setting .....	13
4.3 Motor with External Fan Cooling .....	14
4.4 Electronic Motor Overload Protection .....	15
5 REMOVING AND INSTALLING THE COVER .....	16
5.1 Removing the Cover .....	16
5.2 Installing the cover .....	17
6 INSTALLING THE SUPPLIED FORWARD-STOP-REVERSE SWITCH (REQUIRED FOR MANUAL START MODE) .....	18
7 SETTING SELECTABLE JUMPERS .....	19
7.1 AC Line Input Voltage Selection (Jumper J3) .....	19
7.2 60 Hz and 50 Hz Motor Operation and Drive Output Frequency Selection (Jumpers J1 and J2) .....	19
7.2.1 Setting the Drive for 60 Hz and 50 Hz Motor Operation .....	19
7.2.2 Setting the Drive for Two Times the Rated Motor RPM .....	20
7.3 Automatic and Manual Start Mode (CON1) .....	21
7.3.1 Automatic Start Mode .....	21
7.3.2 Manual Start Mode .....	22
7.4 Forward/Reverse Speed Selection (CON2) .....	22
8 MOUNTING .....	23
9 RECONDITIONING THE BUS CAPACITORS .....	24

---

**TABLE OF CONTENTS (CONTINUED)**

---

<b>Section</b>	<b>Page</b>
10 ELECTRICAL CONNECTIONS.....	24
10.1 AC Line Input and Ground .....	25
10.2 Motor and Ground .....	25
10.3 AC Line Input Fusing .....	26
11 HIGH VOLTAGE DIELECTRIC WITHSTAND TEST (HI-POT).....	27
12 TRIMPOT ADJUSTMENTS.....	28
12.1 Minimum Speed Trimpot (MIN).....	29
12.2 Maximum Speed Trimpot (MAX) .....	29
12.3 Acceleration Trimpot (ACC) .....	29
12.4 Deceleration Trimpot (DEC).....	30
12.5 Slip Compensation Trimpot (COMP) .....	30
12.6 Current Limit Trimpot (CL).....	31
13 DRIVE OPERATION.....	32
13.1 Start-Up Procedure.....	32
13.2 Fault Recovery.....	32
13.3 Restarting the Drive After An Overload Fault Has Cleared .....	33
14 DIAGNOSTIC INDICATORS .....	33
14.1 Illuminated On/Off AC Line Switch .....	34
14.2 Power On LED (PWR).....	34
14.3 Status LED (ST).....	34
LIMITED WARRANTY .....	Back Cover

<b>Table</b>	<b>Page</b>
1 Electrical Ratings.....	9
2 General Performance Specifications .....	9
3 Factory Setting of Current Limit (CL) Trimpot .....	13
4 Terminal Block TB1 Wire and Tightening Torque Specifications .....	25
5 DC Hi-Pot Tester Setup Information.....	27
6 Fault Recovery and Resetting the Drive.....	33
7 Operating Condition and Status LED Indicator .....	34

---

**TABLE OF CONTENTS (CONTINUED)**

---

<b>Figure</b>		<b>Page</b>
1	Cover Layout .....	7
2	Drive Layout .....	8
3	Maximum Allowed Motor Torque vs. Speed .....	14
4	Open Ventilated Motor with External Fan Cooling .....	15
5	Cover Positioned On Top of Case .....	17
6	Forward-Stop-Reverse Switch Installation .....	18
7	AC Line Input Voltage Selection .....	19
8	60 Hz and 50 Hz Motor Selection .....	20
9	Available Torque vs. Output Frequency .....	20
10	120 Hz and 100 Hz Drive Output Frequency Selection .....	21
11	Automatic Start .....	21
12	Manual Start .....	22
13	Forward/Reverse Speed Selection .....	22
14	Mechanical Specifications .....	23
15	AC Line Input, Motor, and Ground Connections .....	26
16	Typical Hi-Pot Test Setup .....	28
17	Minimum Speed Trimpot (MIN) Range .....	29
18	Maximum Speed Trimpot (MAX) Range .....	29
19	Acceleration Trimpot (ACC) Range .....	29
20	Deceleration Trimpot (DEC) Range .....	30
21	Slip Compensation Trimpot (COMP) Range .....	30
22	KBWA-23D CL Trimpot Range .....	31
23	KBWA-22D CL Trimpot Range .....	31
24	KBWA-21D CL Trimpot Range .....	31
25	KBWA-2P6D CL Trimpot Range .....	31
26	KBWA-2P3D CL Trimpot Range .....	31

## 1 FAMILIARIZING YOURSELF WITH THE DRIVE

The drive has a factory installed On/Off AC Line Switch and a Main Speed Potentiometer. It also has provision for a Forward-Stop-Reverse Switch (supplied). See Figure 1. Remove the cover to access the drive's jumpers, connectors, adjustable trim pots, and the terminal block to wire the AC Line input, Motor, and Ground connections. See Figure 2, on page 8.

- **Removing and Installing the Cover:** See Section 5, on pages 16 and 17.
- **Forward-Stop-Reverse Switch (Supplied):** See Section 6, on page 18.
- **Selectable Jumpers:** See Section 7, on pages 18 – 22.
- **Mounting:** See Section 8, on page 23.
- **Electrical Connections:** See Section 10, on pages 24 – 26.
- **Trimpot Adjustments:** See Section 12, on pages 28 – 31.
- **Drive Operation:** See Section 13, on pages 32 and 33.
- **Diagnostic Indicators:** See Section 14, on pages 33 and 34.

**FIGURE 1  
COVER LAYOUT**

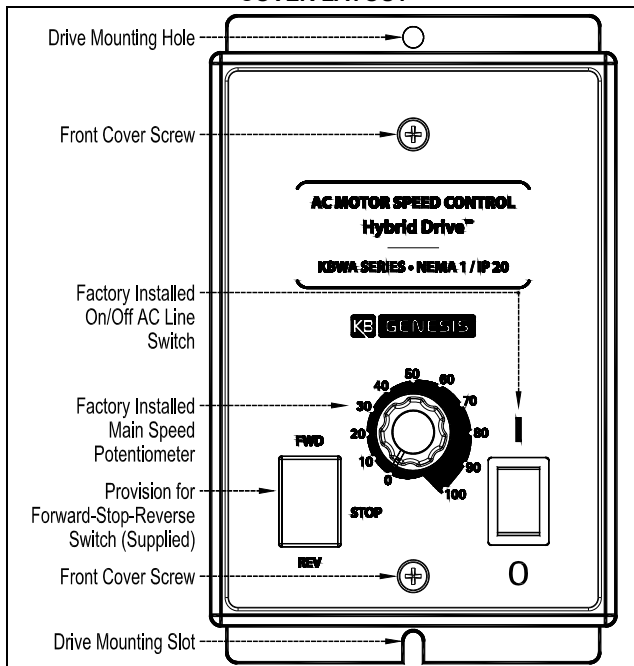

**FIGURE 2**  
**DRIVE LAYOUT**  
**(SHOWN WITH COVER REMOVED)**

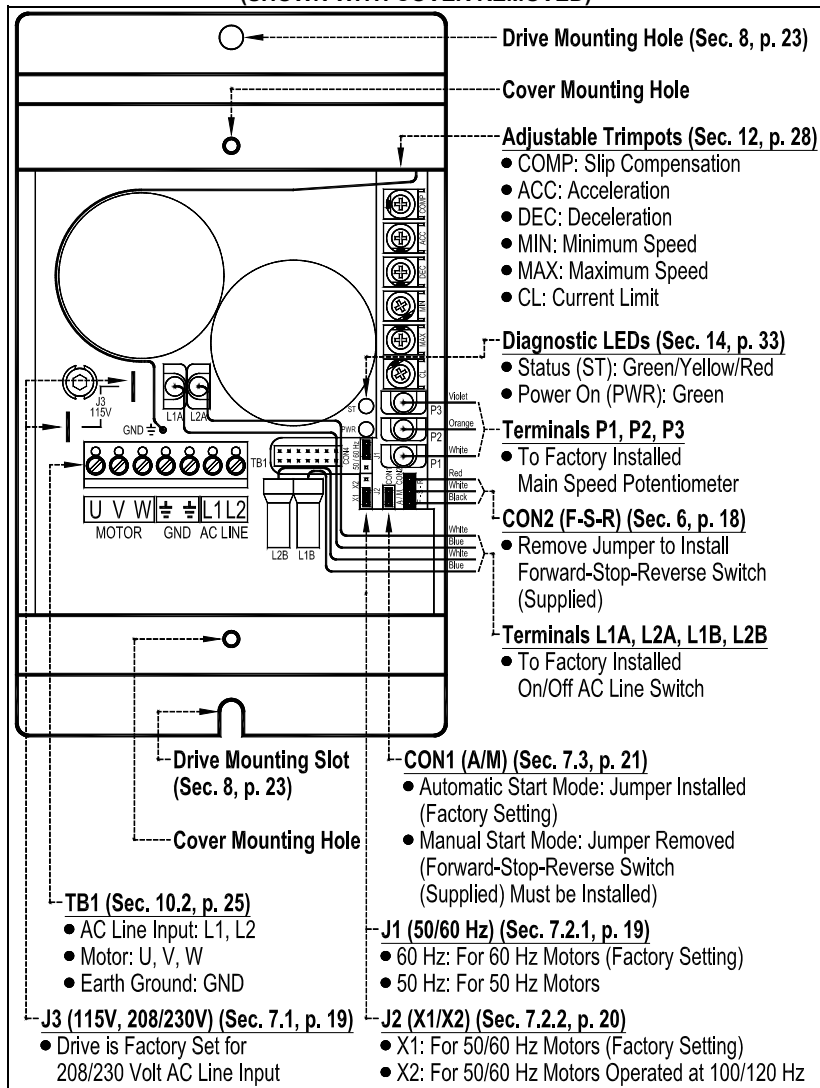



## 2 ELECTRICAL RATINGS AND SPECIFICATIONS

**TABLE 1  
ELECTRICAL RATINGS**

Model No. (Part No.)	Maximum Horsepower (HP (kW))	AC Line Input			Fuse or Circuit Breaker Rating (Amps)	Drive Output		Net Wt.	
		Volts AC (50/60 Hz)	Phase (Φ)	Maximum Current (Amps AC)		Maximum Continuous Load Current (RMS Amps)	Maximum Voltage (Volts AC)	lbs	kg
KBWA-23D (9946)	1/2 (0.37)	115	1	8.8	15	2.2	230	1.6	0.72
		208 / 230	1	6.0	10	2.4			
KBWA-22D (9926)	1/4 (0.18)	115	1	5.2	10	1.3	230	1.5	0.68
		208 / 230	1	3.8	5	1.5			
KBWA-21D (9925)	1/10 (0.07)	115	1	4.0	5	1.0	230	1.5	0.68
		208 / 230	1	2.5	5				
KBWA-2P6D (9923)	Subfractional	115	1	2.4	5	0.6	230	1.5	0.68
		208 / 230	1	1.5	2				
KBWA-2P3D (9922)	Subfractional	115	1	1.2	2	0.3	230	1.5	0.68
		208 / 230	1	0.75	1				

**TABLE 2  
GENERAL PERFORMANCE SPECIFICATIONS**

Description	Specification	Factory Setting
115 Volt AC Line Input Voltage Operating Range (Volts AC)	115 (±15%)	—
208/230 Volt AC Line Input Voltage Operating Range (Volts AC)	208 (-15%) / 230 (+15%)	208/230
Maximum Load (% Current Overload for 2 Minutes)	150	—
Switching Frequency (kHz)	8	—
Output Frequency Resolution (Bits, Hz)	10, 0.06	—
Minimum Speed Trimspot (MLN) Range (% Frequency Setting)	0 – 40	0
Maximum Speed Trimspot (MAX) Range (% Frequency Setting)	70 – 110	100
Acceleration Trimspot (ACC) Range (Seconds)	0.3 – 20	1.5
Deceleration Trimspot (DEC) Range (Seconds)	0.3 – 20	1.5
Slip Compensation Trimspot (COMP) Range at Drive Rating (Volts/Hz)	0 – 3	1.5
Current Limit Trimspot (CL) Range (% Drive Rating)	60 – 190	160
Motor Frequency Setting (Hz) (Jumper J1)	50, 60	60
Output Frequency Multiplier (X1, X2) (Jumper J2) <sup>1</sup>	1, 2	1
Minimum Operating Frequency at Motor (Hz)	1	—
Speed Range (Ratio)	60:1	—
Speed Regulation (30:1 Speed Range, 0 – Full Load) (% Base Speed) <sup>2</sup>	2.5	—
Overload Protection (I <sup>2</sup> t) Trip Time for Stalled Motor (Seconds)	6	—
AC Line Input Undervoltage/Overvoltage Trip Points For 115 Volt AC Line (±5%) (Volts AC) <sup>3</sup>	76 – 141	—
AC Line Input Undervoltage/Overvoltage Trip Points for 208/230 Volt AC Line (±5%) (Volts AC) <sup>3</sup>	151 – 282	—
Operating Temperature Range (°C / °F)	0 – 40 / 32 – 104	—
Operating Humidity Range (% Relative, Non-Condensing)	0 – 95	—
Storage Temperature (°C / °F)	-25 – +85 / -13 – +185	—

**Notes:** 1. Allows the motor to operate up to two times the rated RPM. Constant horsepower will result when operating the drive in the "X2" Mode. 2. Dependent on motor performance. 3. Do not operate the drive outside the specified AC line input voltage operating range.

---

### 3 INTRODUCTION

---

Thank you for purchasing the KBWA Series Hybrid Drive. KB Electronics, Inc. is committed to providing total customer satisfaction by providing quality products that are easy to install and operate.

The KBWA Series are Digital Drives with Analog Interface. Model KBWA-23D is housed in a NEMA 1 / IP20 vented enclosure. Models KBWA-22D, 21D, 2P6D, 2P3D are housed in a NEMA 1 / IP50 non vented enclosure. They are designed to operate subfractional thru 1/2 HP 208 – 230 Volt 50 & 60 Hz 3-phase AC and PSC induction motors.<sup>1</sup> Flux Vector Control provides high torque, low noise, and excellent load regulation over a wide speed range. Adjustable Linear Acceleration and Deceleration make the drive suitable for soft-start applications.

Due to its user-friendly design, the drive is easy to install and operate. Tailoring to specific applications is accomplished with selectable jumpers and trimpots, which eliminate the computer-like programming required on other drives. However, for most applications no adjustments are necessary.

**Main Features:** Adjustable RMS Current Limit and I<sup>2</sup>t Motor Overload Protection.<sup>2</sup> Flux Vector Control with Static Auto-Tune provides high torque and excellent load regulation over a wide speed range. Power Start™ delivers over 200% motor torque to ensure startup of high frictional loads. Electronic Inrush Current Limit (EICL™) eliminates harmful AC line inrush current. The drive is suitable for machine or variable torque (HVAC) applications. A terminal block is provided to facilitate AC line input, motor, and ground connections. Adjustable trimpots (MIN, MAX, ACC, DEC, COMP, CL). Customer selectable jumpers (Automatic/Manual Start, Motor Frequency, Frequency Multiplier, Forward/Reverse, and Line Voltage). PC board mounted diagnostic LEDs provide indication of power on (PWR) and drive status (ST). The drive includes a factory installed Main Speed Potentiometer and an illuminated On/Off AC Line Switch. The drive also has provision for a Forward-Stop-Reverse Switch (supplied) for reversing applications.

**Options:** Custom software for OEM applications. This drive can also be factory programmed to operate with GFCIs – contact our Sales Department.

**Notes:** 1. Operation with PSC motors requires factory programming – contact our Sales Department. 2. UL approved as an overload protector for motors.

### 3.1 STANDARD FEATURES

- **Model KBWA-23D:** Housed in a NEMA 1 / IP20 vented enclosure.
- **Models KBWA-22D, 21D, 2P6D, 2P3D:** Housed in a NEMA 1 / IP50 non vented enclosure.
- **Dual Voltage AC Line Input Operation:** The drive operates from 115 and 208/230 Volt 50/60 Hz AC Line input. See Section 7.1, on page 19.
- **Simple to Operate:** Does not require programming. Uses trimpots and jumpers, which are factory set for most applications.
- **Factory Installed On/Off AC Line Switch:** The switch illuminates when power is applied to the drive and the switch is in the on position.
- **Factory Installed Main Speed Potentiometer:** Provides adjustment of motor speed.
- **Diagnostic LEDs:** Power on (PWR) and drive status (ST). See Sections 14.2 and 14.3, on page 34.
- **Jumper Selection for Drive Output Frequency (Jumpers J1 and J2):** Increases motor speed up to two times the rated RPM. See Section 7.2, on pages 19 – 21.
- **Jumper Selection for Automatic and Manual Start (CON1):** With the jumper installed, the drive will automatically start after a fault has been cleared. With the jumper removed, the drive must be manually restarted, after a fault has been cleared. The supplied Forward-Stop-Reverse Switch must be installed for Manual Start Operation. See Section 7.3, on pages 21 and 22.
- **Jumper Selection for Motor Direction (CON2):** Allows selection of Forward or Reverse direction. See Section 7.4, on page 22. The supplied Forward-Stop-Reverse Switch can be installed to provide motor reversing and stop, as described in Section 6, on pages 16 and 17.
- **Forward-Stop-Reverse Switch (Supplied):** Easily Installs in the drive. See Section 6, on page 18.

### 3.2 PERFORMANCE FEATURES

- **Power Start™:** Provides more than 200% starting torque which ensures startup of high frictional loads.
- **Flux Vector Control with Static Auto-Tune:** Provides excellent load regulation over a wide speed range.
- **Speed Range:** 60:1

### 3.3 PROTECTION FEATURES

- **Motor Overload (I<sup>2</sup>t) with RMS Current Limit:** Provides motor overload protection which prevents motor burnout and eliminates nuisance trips. UL approved as an overload protector for motors. See Section 12.6, on page 31.
- **Electronic Inrush Current Limit (EICL™):** Eliminates harmful inrush AC line current during startup.
- **Short Circuit:** Prevents drive failure if a short circuit occurs at the motor (phase-to-phase).
- **Regeneration:** Eliminates nuisance tripping due to bus overvoltage caused by rapid deceleration of high inertial loads.
- **Undervoltage and Overvoltage:** Shuts down the drive if the AC line input voltage goes above or below the operating range.
- **MOV Input Transient Suppression.**
- **Microcontroller Self Monitoring and Auto-Reboot.**

### 3.4 SELECTABLE JUMPERS

- **J1 (50/60 Hz):** Used to set the drive for 60 Hz motors (factory setting) or 50 Hz motors. See Section 7.2.1, on pages 19 and 20.
- **J2 (X1/X2):** Used to set the drive output for twice the motor rated speed (120 Hz (factory setting) or 100 Hz). See Section 7.2.2, on pages 20 and 21.
- **J3 (115V):** The drive is factory set for 230 Volt AC Line input (J3 not installed). For 115 Volt AC Line input, install Jumper J1 (supplied). See Section 7.1, on page 19.
- **CON1 (A/M):** Used to set the drive for Automatic or Manual Start Mode. See Section 7.3, on pages 21 and 22.
- **CON2 (Forward/Reverse):** Used to set the drive for forward or reverse speed operation. See Section 7.4, on page 22. Also used to install the supplied Forward-Stop-Reverse Switch. See Section 6, on page 18.

### 3.5 ADJUSTABLE TRIMPOTS

- **Minimum Speed (MIN):** Sets the minimum speed of the motor. See Section 12.1, on page 29.
- **Maximum Speed (MAX):** Sets the maximum speed of the motor. See Section 12.2, on page 29.
- **Acceleration (ACC):** Sets the amount of time for the motor to accelerate from zero speed to full speed. See Section 12.3, on page 29.
- **Deceleration (DEC):** Sets the amount of time for the motor to decelerate from full speed to zero speed. See Section 12.4, on page 30.
- **Slip Compensation (COMP):** Used to fine tune the drive for improved load regulation when required by the application. See Section 12.5, on page 30.
- **Current Limit (CL):** Sets the current limit (overload) which limits the maximum current (torque) to the motor. See Section 12.6, on page 31.

### 3.6 CUSTOMIZATION FOR OEMs

- **Custom Software:** The drives are preset and ready to use "out-of-the-box". Custom front panels are also available. The drive can be factory programmed for applications that require special switching, timing, PLC functions, and GFCI operation. Contact our Sales Department.

---

## 4 IMPORTANT APPLICATION INFORMATION

---

### 4.1 50 Hz MOTORS

The drive is factory set for 60 Hz motors (Jumper J1 set to the "60 Hz" position). For 50 Hz motors, set Jumper J1 to the "50 Hz" position. Be sure Jumper J2 is set to the "X1" position (factory setting). See Section 7.2.1, on pages 19 and 20.

### 4.2 MOTOR CURRENT SETTING

The Current Limit (CL) Trimpot is factory set to approximately 160% of the drive's Maximum Continuous Load Current Rating, as shown in Table 3.

In order for the Motor Overload Protection to operate properly for a lower motor rated current, the CL Trimpot will have to be readjusted. **Do not exceed 160% of the drive's Maximum Continuous Load Current Rating.** See Section 12.6, on page 31.

**TABLE 3**  
**FACTORY SETTING OF CURRENT LIMIT (CL) TRIMPOT**

Model No.	Drive Rating (Maximum Continuous Load Current) (RMS Amps)	CL Trimpot Setting (Drive Rating X 160%) (RMS Amps)
KBWD-23D	2.4	3.8
KBWD-22D	1.5	2.4
KBWD-21D	1.0	1.6
KBWD-2P6D	0.6	1.0
KBWD-2P3D	0.3	0.5

### 4.3 MOTOR WITH EXTERNAL FAN COOLING

Most totally enclosed fan-cooled (TEFC) and open ventilated 3-phase AC induction motors will overheat if used beyond a limited speed range at full torque. Therefore, it is necessary to reduce motor load as speed is decreased.

**Note:** Some fan-cooled motors can be used over a wider speed range. Consult the motor manufacturer for details.

**⚠ WARNING!** Some motors have low speed characteristics which cause overheating and winding failure under light load or no load conditions. If the motor is operated in this manner for an extended period of time, it is recommended that the unloaded motor current be checked from 1 – 5 Hz (30 – 150 RPM) to ensure motor current does not exceed the nameplate rating. **Do not use motor if the motor current exceeds the nameplate rating.**

**⚠** It is recommended that the drive be used with Inverter Duty or TENV motors.

Inverter duty and most totally enclosed non-ventilated (TENV) motors can provide full rated torque over an extended speed range without overheating. See Figure 3.

**FIGURE 3**  
**MAXIMUM ALLOWED MOTOR TORQUE vs. SPEED**

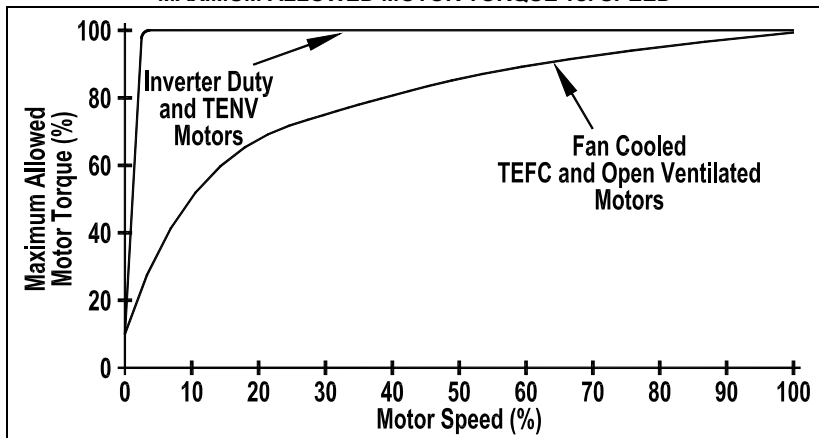

If external fan cooling is provided, open ventilated motors can also achieve an extended speed range at full rated torque. A box fan or blower with a minimum of 100 CFM per HP is recommended. Mount the fan or blower so the motor is surrounded by the airflow. See Figure 4.

**FIGURE 4**  
**OPEN VENTILATED MOTOR WITH EXTERNAL FAN COOLING**

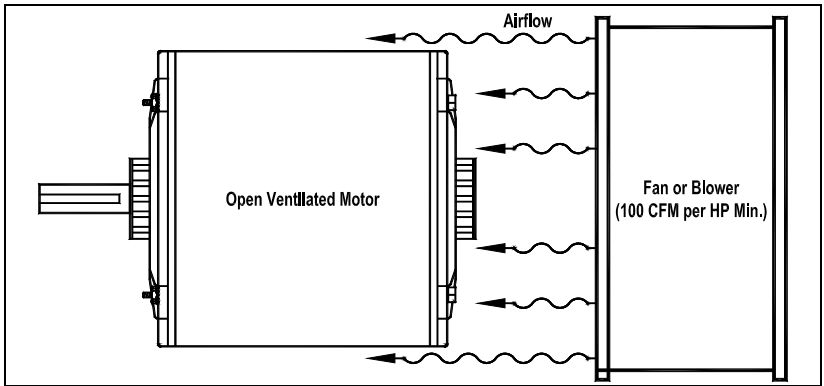

#### **4.4 ELECTRONIC MOTOR OVERLOAD PROTECTION**

The drive contains Modified  $I^2t$  Overload Protection (UL approved as an overload protector for motors). Part of this function consists of a Current Limit (CL) circuit, which limits the drive current to a factory preset level of 160% of the rated drive current. The CL Trimpot is used to recalibrate the drive current from 60% thru 190%. The Power Start™ circuit provides an overshoot function that allows most motors to develop more than 200% of starting torque and breakdown torque.

Standard  $I^2t$  is undesirable because it causes nuisance tripping. It allows a very high motor current to develop and will turn the drive off after a very short period of time. KB's RMS Current Limit Circuit avoids this nuisance tripping while providing maximum motor protection.

If the motor is overloaded to 120% of full load (75% of the CL setting), the  $I^2t$  Timer starts. If the motor continues to be overloaded at the 120% level, the timer will shut down the drive after 30 minutes. If the motor is overloaded to 160% of full load, the drive will trip in 6 seconds.

---

## 5 REMOVING AND INSTALLING THE COVER

---

The cover must be removed to set up the drive. See Section 5.1, below, for instructions on removing the cover. See Section 5.2, on page 17, for instructions on installing the cover.

Model KBWA-23D is housed in a NEMA 1 / IP20 vented enclosure. Models KBWA-22D, 21D, 2P6D, 2P3D are housed in a NEMA 1 / IP50 non vented enclosure.

**Note:** To install the supplied Forward-Stop-Reverse Switch, remove the cover, as described in Section 5.1, below, and follow the instructions in Section 6, on page 18.

- **Jumper Settings:** See Section 7, on pages 19 – 22.
- **AC Line, Motor, and Ground Connections:** See Sections 10, on pages 24 – 26.
- **Trimpot Adjustments:** See Section 12, on pages 28 – 31.



**WARNING!** Disconnect the main power before removing or installing the cover.



**WARNING!** After disconnecting the main power to the drive, wait at least 30 seconds before removing the cover.



**WARNING!** To prevent accidental contact with high voltage, it is required that the cover be properly installed onto the drive after all wiring and setup is complete. It offers protection against electric shock which limits the potential liability to the equipment manufacturer and installer.

### 5.1 REMOVING THE COVER

Remove the two screws on the cover and slide it off the drive's base. Be careful not to separate the wires from the drive to the cover's On/Off AC Line Switch and Main Speed Potentiometer.

To facilitate wiring the drive, place the cover on top of the case, as shown in Figure 5, on page 17.



**FIGURE 5**  
**COVER POSITIONED ON TOP OF CASE**  
**(All Wires Omitted for Clarity)**

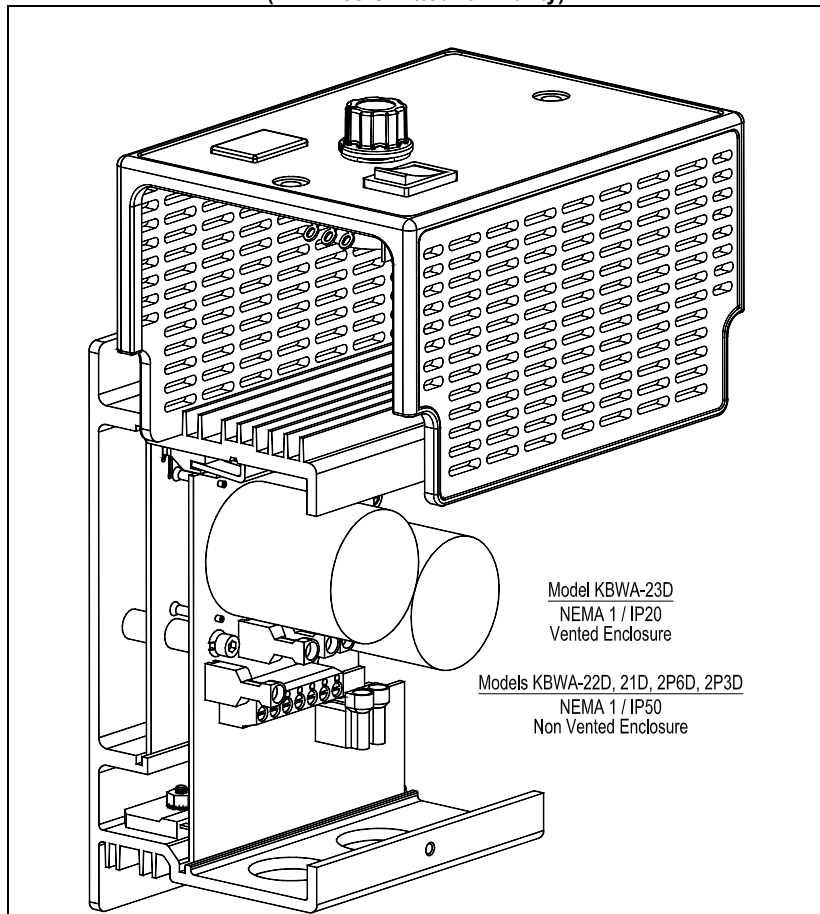

## **5.2 INSTALLING THE COVER**

After setting up the drive, install the cover. Be sure that the wires remain inside the drive so they do not get crimped while it is being installed. Replace the two cover screws. The screws should be tightened to 5 in-lbs (5.76 kg-cm) – do not overtighten.

## 6 INSTALLING THE SUPPLIED FORWARD-STOP-REVERSE SWITCH

The Forward-Stop-Reverse Switch is used to change motor direction. The switch assembly easily installs onto the cover. Follow steps 1 – 10, below, and see Figure 6.



**WARNING! Disconnect the main power before installing the Forward-Stop-Reverse Switch.**

### Installing the Forward-Stop-Reverse Switch

1. Remove the cover, as described in Section 5.1, on pages 16 and 17.
2. Remove the hole plug from the cover.
3. Remove the jumper from CON2 (F-S-R).
4. Feed the connector with the switch wires through the cover.
5. Orient the switch (red wire toward "FWD" and white wire toward "REV").
6. Push the switch through the cover hole until it snap-mounts into position.
7. Orient the connector (red wire to "R" pin and white wire to "F" pin).\*
8. Install the connector onto CON2 on the drive.
9. Use the two wire ties (supplied) to secure the switch wires to the existing wires. The wire ties should be placed next to the existing wire ties.
10. Replace the cover, as described in Section 5.2, on page 17.

*\*If the motor does not rotate in the desired direction, reverse the connector on CON2, from step 7, above (with the AC Line disconnected and the motor stopped).*

### FIGURE 6 FORWARD-STOP-REVERSE SWITCH INSTALLATION

(On/Off AC Line Switch and Main Speed Potentiometer Wires are Omitted for Clarity)

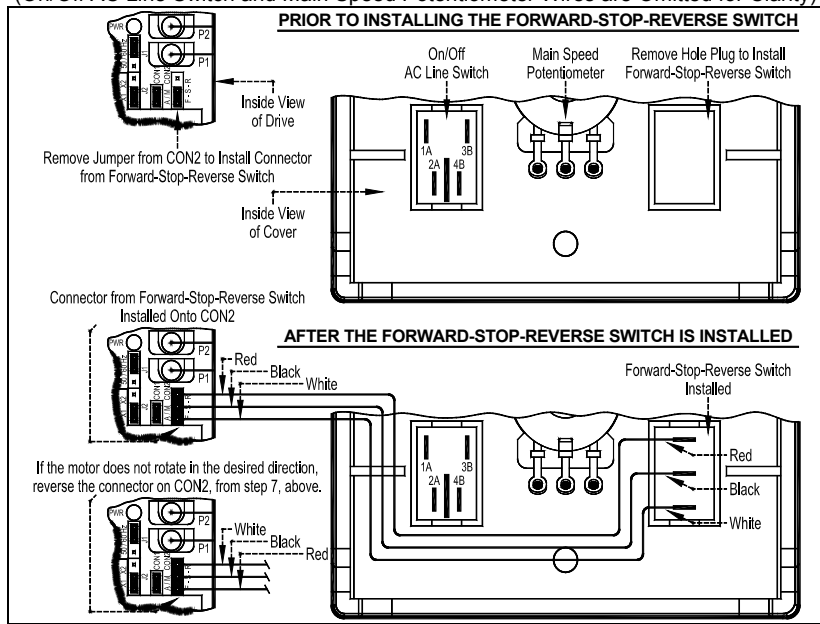

---

## 7 SETTING SELECTABLE JUMPERS

---

The drive has selectable jumpers which must be set before the drive can be used. For the location of jumpers, see Figure 2, on page 8.

### 7.1 AC LINE INPUT VOLTAGE SELECTION (JUMPER J3)

The drive is factory set for 208/230 Volt AC Line input (Jumper J3 not installed). For 115 Volt AC line input, install Jumper J3 (supplied) onto the two PC board quick-connect terminals. See Figure 7.

*Note: 230 Volts AC will be applied to the motor with 115 Volt AC line input.*

**FIGURE 7**  
**AC LINE INPUT VOLTAGE SELECTION**

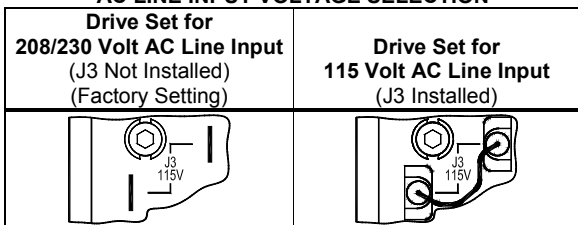

### 7.2 60 Hz AND 50 Hz MOTOR OPERATION AND DRIVE OUTPUT FREQUENCY SELECTION (JUMPERS J1 AND J2)

Both Jumpers J1 and J2 must be set for the appropriate motor nameplate frequency rating.

#### 7.2.1 SETTING THE DRIVE FOR 60 Hz OR 50 Hz MOTOR OPERATION

The drive is factory set to operate 60 Hz motors. Jumper J1 is factory set to the "60 Hz" position and Jumper J2 is factory set to the "X1" position. For 50 Hz motors, set Jumper J1 to the "50 Hz" position, and be sure Jumper J2 is set to the "X1" position. See Figure 8, on page 20.

**FIGURE 8**  
**60 Hz AND 50 Hz MOTOR SELECTION**

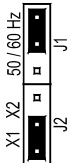
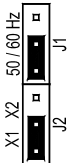
<b>60 Hz Motor Operation</b> (Factory Setting) (J1 Installed in "60 Hz" Position) (J2 Installed in "X1" Position)	<b>50 Hz Motor Operation</b> (J1 Installed in "50 Hz" Position) (J2 Installed in "X1" Position)
	

### 7.2.2 SETTING THE DRIVE FOR TWO TIMES THE RATED MOTOR RPM

The drive can also be used to operate the motor up to two times the rated RPM. However, constant horsepower will result when operating the drive in the "X2" Mode. See Figure 9.

**FIGURE 9**  
**AVAILABLE TORQUE vs. OUTPUT FREQUENCY**

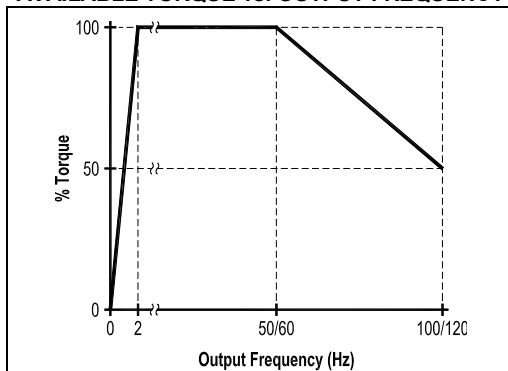

For 120 Hz output with 60 Hz motor, be sure Jumper J1 is set to the "60 Hz" position and set Jumper J2 to the "X2" position. For 100 Hz output with 50 Hz motor, set Jumper J1 to the "50 Hz" position and set Jumper J2 to the "X2" position. See Figure 10.

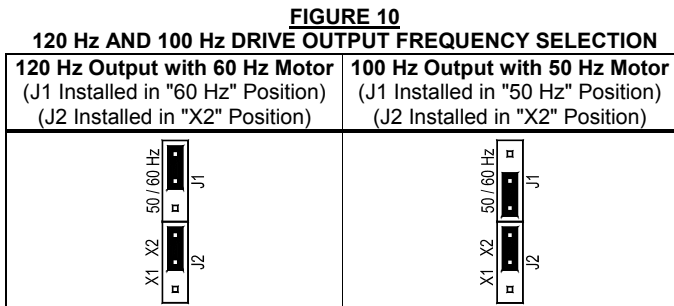

### 7.3 AUTOMATIC AND MANUAL START MODE (CON1)

CON1 is used to set the drive for Automatic or Manual Start Mode.

#### 7.3.1 AUTOMATIC START MODE

The drive is factory set for Automatic Start Mode (jumper installed onto CON1). See Figure 11.

The drive will automatically start when power is applied. The drive will also automatically restart after a recovered fault due to undervoltage or overvoltage. After two Short Circuit Faults (at the motor), the drive must be restarted using the AC Line Switch. For an Overload Trip, due to a prolonged overload, the drive must be manually restarted using the AC Line Switch or the Forward-Stop-Reverse Switch, if installed.

**FIGURE 11**  
**AUTOMATIC START**  
(Jumper Installed Onto CON1)  
(Factory Setting)

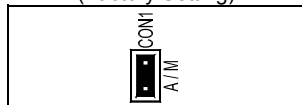

### 7.3.2 MANUAL START MODE

The Manual Start Mode is used to manually start the drive or restart the drive (reset) if a fault has occurred. Remove the jumper that is installed on CON1. See Figure 12.

**FIGURE 12**  
**MANUAL START**  
(Jumper Removed from CON1)

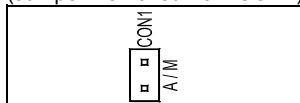

**Important Note:** To operate the drive in the Manual Start Mode, the supplied Forward-Stop-Reverse Switch must be installed. See Section 6, on page 18.

In the Manual Start Mode, the drive will trip due to all faults (Overvoltage, Undervoltage, Short Circuit, and Overload Trip) and remain tripped even when the fault is cleared.

To reset the drive after a fault has cleared, set the Forward-Stop-Reverse Switch to the "STOP" position and then to the desired direction. Also, the drive must be restarted each time the AC line is interrupted. To reset the drive after a Short Circuit Fault has cleared, use the AC Line Switch.

### 7.4 FORWARD/REVERSE SPEED SELECTION (CON2)

The drive is factory set for Forward Speed Operation (jumper installed in the "F" position of CON2). For reverse Speed Operation, install the jumper in the "R" position. See Figure 13. If the application requires that the direction be changed repeatedly, install the supplied Forward-Stop-Reverse Switch. See Section 6, on page 18.

**Note:** As an alternate to using the F-S-R jumper, reverse any two motor leads (with the AC Line disconnected and the motor stopped).

**FIGURE 13**  
**FORWARD/REVERSE SPEED SELECTION**

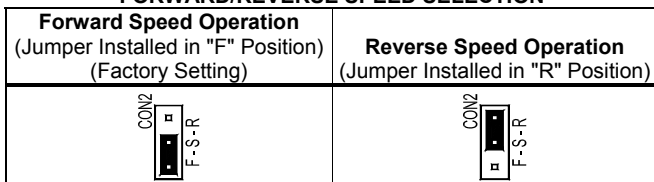

## 8 MOUNTING

Use the supplied mounting template to facilitate locating the holes to mount the drive. It is recommended that the drive be mounted vertically on a flat surface with adequate ventilation. Leave enough room below the drive to allow for AC Line, motor connections, and any other connections that are required. Care should be taken to avoid extreme hazardous locations where physical damage can occur. When mounting the drive in an enclosure, the enclosure should be large enough to allow proper heat dissipation so that the ambient temperature does not exceed 40 °C (104 °F) at full rating. See Figure 14.



**WARNING! DO NOT USE THIS DRIVE IN AN EXPLOSIVE ENVIRONMENT. AN EXPLOSION CAN CAUSE SERIOUS OR FATAL INJURY. THIS DRIVE IS NOT EXPLOSION PROOF.**

**FIGURE 14**  
**MECHANICAL SPECIFICATIONS (INCHES / mm)**

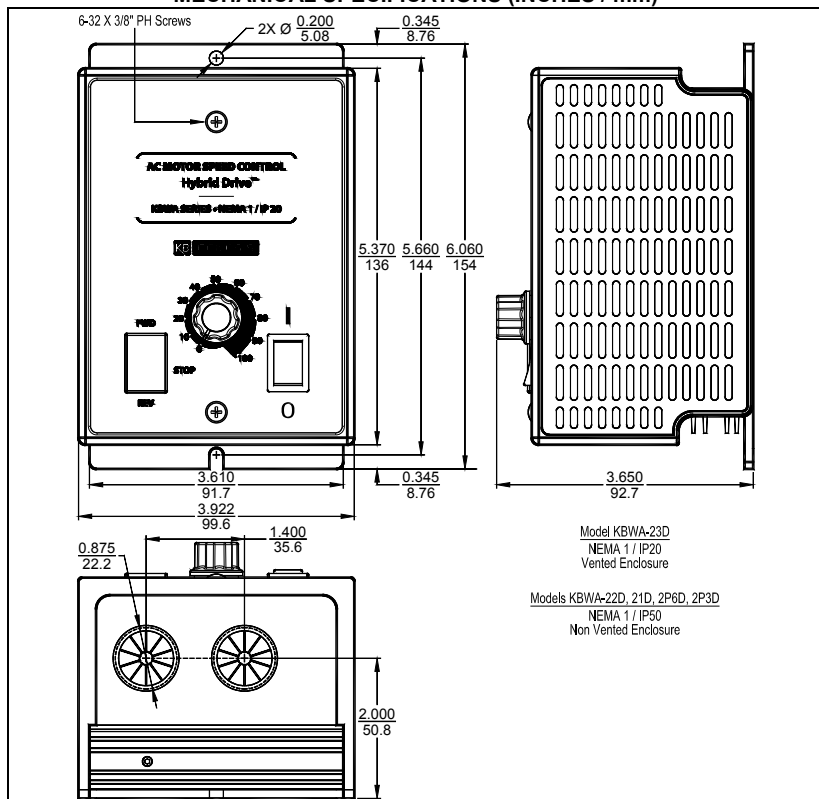

---

## 9 RECONDITIONING THE BUS CAPACITORS

---

This drive contains bus capacitors which must be reconditioned if the drive has been in storage for over one year. To recondition the capacitors, apply the AC Line for a minimum of one hour, with the Main Speed Potentiometer set to zero, or set the Forward-Stop-Reverse Switch, if installed, to the Stop position.

---

## 10 ELECTRICAL CONNECTIONS

---

The drive is designed with a PC board mounted terminal block to facilitate wiring of the AC Line input, Motor, and Ground connections, as shown in Figure 2, on page 8. The removable cover allows access to the terminal block, jumpers, and trimpots for wiring and setting up the drive. For Terminal Block TB1 Wire and Tightening Torque Specifications, see Table 4, on page 25.

The drive is designed with two 0.875" (22.2 mm) holes for standard 3/4" fittings for wiring the AC Line input, motor and ground.

**Note:** *Wire the control in accordance with the National Electrical Code requirements and other local codes that may apply to the application.*



**WARNING! HIGH VOLTAGE!** Read Safety Warning, on page 2, before using the drive. Disconnect the main power before making connections to the drive. To avoid electric shock, be sure to properly ground the drive.

**Application Notes:** **1.** To avoid erratic operation, do not bundle AC Line input and motor wires with each other. Also, do not bundle motor wires from multiple drives in the same conduit. **2.** Be sure to properly fuse each AC Line conductor that is not at ground potential. Do not fuse neutral or grounded conductors. A separate AC Line switch or contactor must be used as a disconnect so that each ungrounded conductor is opened. For fuse or circuit breaker selection, see Table 1, on page 9. Also see Section 10.3, on page 26.



**TABLE 4**  
**TERMINAL BLOCK TB1**  
**WIRE AND TIGHTENING TORQUE SPECIFICATIONS**

Copper Wire Size Range (Solid or Stranded*)		Stripping Length		Tightening Torque Range	
AWG	mm <sup>2</sup>	in	mm	in-lbs	kg-cm
30 – 14	0.05 – 2.08	0.25	6	4.4 – 5.3	5.1 – 6.1

*\*If using stranded wire, be sure that all strands are contained in the terminal block housing.*

## 10.1 AC LINE INPUT AND GROUND

Connect the single-phase AC line input to TB1 Terminals "L1" and "L2". Connect the Ground (earth) to TB1 Terminal "GND". See Figure 15, on page 26. **For 208/230 Volt AC Line input, be sure that Jumper J3 is not installed (factory setting). For 115 Volt AC Line input, install Jumper J3 (supplied). See Section 7.1, on page 19.**

**Note:** *The actual AC Line Input voltage must correspond to the setting of Jumper J3. For 208/230 Volt AC Line Input, be sure that Jumper J3 is not installed. For 115 Volt AC Line input, install Jumper J3 (supplied). Applying 230 Volts to the drive set for 115 Volt AC Line input will cause catastrophic failure.*

## 10.2 MOTOR AND GROUND

Connect the Motor to TB1 Terminals "U", "V", and "W". Connect the Ground (earth) to TB1 Terminal "GND". See Figure 15, on page 26.

Motor cable length should not exceed 100 feet (30 m) – special reactors may be required – consult our Sales Department.

Be sure that the Current Limit is calibrated to the actual motor nameplate current rating. Do not exceed the drive's maximum current rating.

**Note:** *If the motor does not rotate in the desired direction, either: 1. Reverse any two motor leads (with the AC Line disconnected and the motor stopped). 2. Change the setting of the F-S-R Jumper, on CON2. See Section 7.4, on page 22. 3. If the Forward-Stop-Reverse Switch is installed, reverse the connector installed on CON2. See Section 6, on page 18.*

**FIGURE 15**  
**AC LINE INPUT, MOTOR, AND GROUND CONNECTIONS**

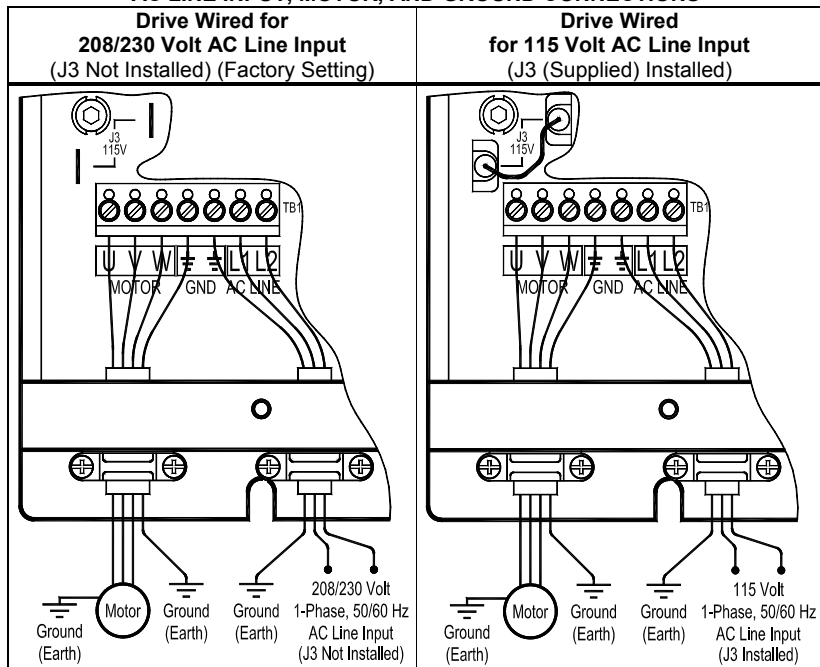

### 10.3 AC LINE INPUT FUSING

The drive does not contain AC Line fuses. For the recommended fuse or circuit breaker rating, see Table 1, on page 9. Do not fuse motor leads. Most electrical codes require that each ungrounded conductor contain circuit protection. Do not fuse neutral or ground connections. It is recommended to install a fuse (Littelfuse 326, Buss ABC, or equivalent) or a circuit breaker (Square D QOU or equivalent) in series with each ungrounded conductor.

---

## 11 HIGH VOLTAGE DIELECTRIC WITHSTAND TEST (HI-POT TEST)

---

### DESCRIPTION

Testing agencies such as UL, CSA, etc., usually require that equipment undergo an AC Hi-Pot Test. In order to prevent catastrophic damage to the drive, which has been installed in the equipment, the following procedure is recommended. A typical Hi-Pot Test Setup is shown in Figure 16, on page 28.

**All drives have been factory hi-pot tested in accordance with UL requirements.**

**DC Hi-Pot Test Voltage = ((Line Voltage X 2) + 1000) X 1.41**

**TABLE 5**  
**DC HI-POT TESTER SETUP INFORMATION**

<b>Input Line Voltage (Volts AC)</b>	<b>Hi-Pot Test Voltage (Volts DC)</b>
115	1800
208/230	2100

### EQUIPMENT

A ramp-up type AC Hi-Pot Tester must be used. A suggested Hi-Pot Tester is Slaughter Model 2550, or equivalent.

*Note: If the Hi-Pot Tester does not have automatic ramping, then the hi-pot output must be manually increased to the test voltage and then manually reduced to zero.*

### PROCEDURE



**Warning!** All equipment AC line inputs must be disconnected from the AC power before performing the Hi-Pot Test.

1. Set the Hi-pot Tester to the appropriate voltage, as shown in Table 5, above.
2. Connect all equipment AC power input lines together and connect them to the H.V. lead of the Hi-Pot Tester.
3. Connect the RETURN of the Hi-Pot Tester to the frame on which the drive and other auxiliary equipment are mounted. The Hi-Pot Tester must have an automatic ramp-up to the test voltage and an automatic ramp-down to zero voltage.

**CAUTION!** Instantly applying the hi-pot voltage will cause irreversible damage to the drive, which will void the warranty.

**FIGURE 16**  
**TYPICAL HI-POT TEST SETUP**

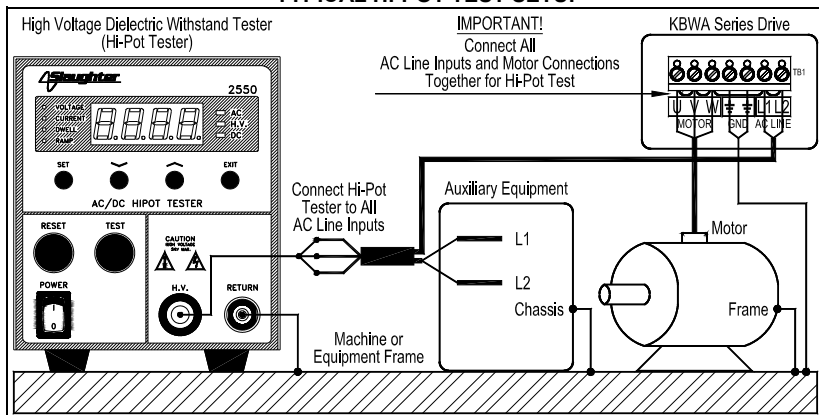

## 12 TRIMPOT ADJUSTMENTS

The drive contains trimpots which are factory set for most applications. See Figure 2, on page 8, for the location of the trimpots and their approximate factory calibrated positions. Some applications may require readjustment of the trimpots in order to tailor the drive for a specific requirement. The trimpots may be readjusted as follows.



**WARNING!** If possible, do not adjust trimpots with the main power applied. If adjustments are made with the main power applied, an insulated adjustment tool must be used and safety glasses must be worn. High voltage exists in this drive. Fire and/or electrocution can result if caution is not exercised. Safety Warning, on page 2, must be read and understood before proceeding.

### 12.1 MINIMUM SPEED TRIMPOT (MIN)

Sets the minimum speed of the motor. The MIN Trimpot is factory set to 0% of frequency setting.

For a higher minimum speed setting, rotate the MIN Trimpot clockwise. See Figure 17.

**FIGURE 17**  
**MINIMUM SPEED TRIMPOT (MIN) RANGE**

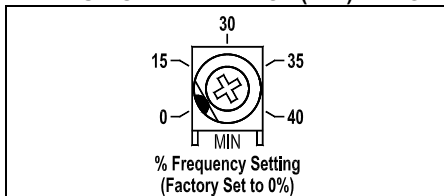

### 12.2 MAXIMUM SPEED TRIMPOT (MAX)

Sets the maximum speed of the motor. The MAX Trimpot is factory set to 100% of frequency setting.

For a higher maximum speed setting, rotate the MAX Trimpot clockwise. For a lower maximum speed setting, rotate the MAX Trimpot counterclockwise. See Figure 18.

**FIGURE 18**  
**MAXIMUM SPEED TRIMPOT (MAX) RANGE**

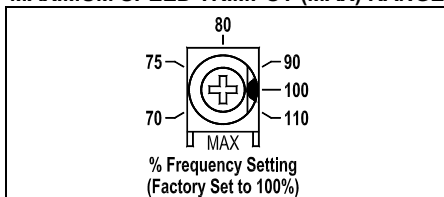

### 12.3 ACCELERATION TRIMPOT (ACC)

Sets the amount of time for the motor to accelerate from zero speed to full speed. The ACC Trimpot is factory set to 1.5 seconds.

For longer acceleration time, rotate the ACC Trimpot clockwise. For more rapid acceleration, rotate the ACC Trimpot counterclockwise. See Figure 19.

**FIGURE 19**  
**ACCELERATION TRIMPOT (ACC) RANGE**

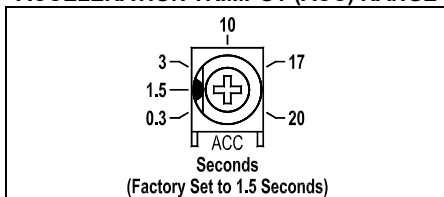

**Note:** Rapid acceleration settings may cause the current limit circuit to activate, which will extend the acceleration time.

## 12.4 DECELERATION TRIMPOT (DEC)

Sets the amount of time for the motor to decelerate from full speed to zero speed. The DEC Trimpot is factory set to 1.5 seconds.

For longer deceleration time, rotate the DEC Trimpot clockwise. For more rapid deceleration, rotate the DEC Trimpot counterclockwise. See Figure 20.

**FIGURE 20  
DECELERATION  
TRIMPOT (DEC) RANGE**

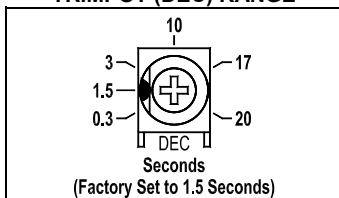

**Application Note:** On applications with high inertial loads, the deceleration may automatically increase in time. This will slow down the rate of speed of decrease to prevent the bus voltage from rising to the Overvoltage Trip point. This function is called Regeneration Protection. **It is recommended that for very high inertial loads that both the ACC and DEC Trimpots should be set to greater than 10 seconds.**

## 12.5 SLIP COMPENSATION TRIMPOT (COMP)

Sets the amount of Volts/Hz to maintain set motor speed under varying loads. Used to fine tune the drive for improved load regulation. The COMP Trimpot is factory set to 1.5 Volts/Hz, which provides excellent speed regulation for most motors.

To increase the slip compensation, rotate the COMP Trimpot clockwise.\* To decrease the slip compensation, rotate the COMP Trimpot counterclockwise. See Figure 21.

**FIGURE 21  
SLIP COMPENSATION  
TRIMPOT (COMP) RANGE**

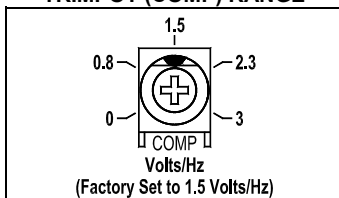

**\*Note:** Increasing the Slip Compensation beyond what is required may cause unstable motor operation.

## 12.6 CURRENT LIMIT TRIMPOT (CL)

Motor Overload ( $I^2t$ ) with RMS Current Limit (CL) sets the current limit (overload), which limits the maximum current to the motor, prevents motor burnout, and eliminates nuisance trips. In order to ensure that the motor is properly protected with the  $I^2t$  feature, it is required that the CL Trimpot be set for 160% of the motor nameplate rating.

The CL Trimpot is factory set to 160% of the drive's Maximum Continuous Load Current rating. To increase the current limit, rotate the CL Trimpot clockwise. To decrease the current limit, rotate the CL Trimpot counterclockwise. See Figures 22 – 26.

**Note:** During normal operation, if the ST LED illuminates red, the CL Trimpot may be set too low or the motor may be overloaded. Either increase the CL Trimpot setting or monitor the motor current to adjust the CL Trimpot for the proper setting.

**FIGURE 22**

**KBWA-23D CL TRIMPOT RANGE**

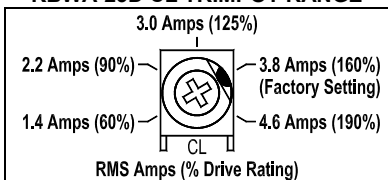

**FIGURE 23**

**KBWA-22D CL TRIMPOT RANGE**

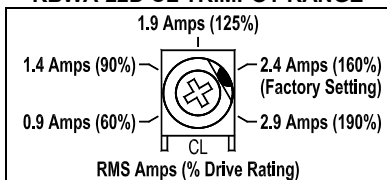

**FIGURE 24**

**KBWA-21D CL TRIMPOT RANGE**

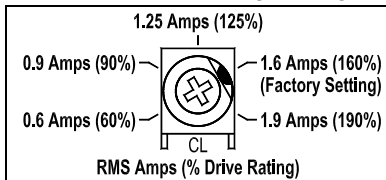

**FIGURE 25**

**KBWA-2P6D CL TRIMPOT RANGE**

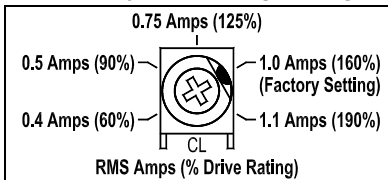

**FIGURE 26**

**KBWA-2P3D CL TRIMPOT RANGE**

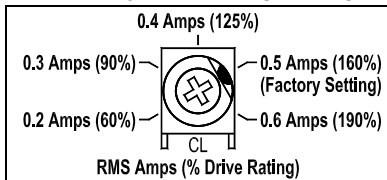

---

## 13 DRIVE OPERATION

---

### 13.1 START-UP PROCEDURE

After the drive has been properly setup (jumpers and trimpots set to the desired positions) and wiring completed, the startup procedure can begin.



**WARNING!** The motor will run at the Main Speed Potentiometer setting when the AC Line is applied to the drive and the On/Off AC Line Switch is set to the on position.

To start the drive, set the On/Off AC Line Switch to the "On" ("I") position. If the AC power has been properly brought to the drive, the On/Off AC Line Switch will illuminate. If the optional Forward-Stop-Reverse Switch has been installed, set it to either the "FORWARD" or "REVERSE" position. The motor will begin to accelerate according to the Main Speed Potentiometer setting.

**If the Cover Is Removed:** Observe that the PC board mounted Power On LED (PWR) illuminates green. The PC board mounted Status LED (ST) will indicate the drive status, as described in Section 14.3, on page 34.

**Note:** *If the motor does not rotate in the desired direction, either: 1. Reverse any two motor leads (with the AC Line disconnected and the motor stopped). 2. Change the setting of the F-S-R Jumper, on CON2. See Section 7.4, on page 22. 3. If the Forward-Stop-Reverse Switch is installed, reverse the connector installed on CON2. See Section 6, on page 18.*

### 13.2 FAULT RECOVERY

The drive monitors four faults (Undervoltage, Overvoltage, Short Circuit (at the motor (phase-to-phase)), and Motor Overload). Table 6, on page 33, describes how the drive will recover after the fault has cleared. For an Overload Trip, see Section 13.3, on page 33.

**Application Note:** In Manual Start Mode (the Forward-Stop-Reverse Switch must be installed); the drive must be manually reset for any fault. Set the Forward-Stop-Reverse Switch to the "STOP" position and then to the desired direction setting. See Section 6, on page 18.



**TABLE 6**  
**FAULT RECOVERY AND RESETTING THE DRIVE\***  
**(In Automatic Start Mode (Jumper Installed Onto CON1 (Factory Setting))**

Fault	Drive Recovery
Undervoltage	Drive will automatically start after the bus voltage returns to the operational level or when the drive is first turned on (power up).
Overvoltage	Drive will automatically start after the bus voltage returns to the operational level.
Short Circuit	After two faults, the drive must be restarted using the AC line.
Motor Overload ( $I^2t$ )	Drive must be manually restarted. See Section 13.3, below.

*\*The fault must be cleared before the drive can be reset.*

### **13.3 RESTARTING THE DRIVE AFTER AN OVERLOAD FAULT HAS CLEARED**

The drive can be restarted after an Overload Fault has cleared by any of the following two methods.

**Note:** *If an Overload Trip occurs, the motor may be overloaded. Check the motor current with an AC RMS responding ammeter. Also, the CL setting may be set too low. See Section 12.6, on page 31.*

1. Use the On/Off AC Line Switch to turn the power off and on (approximately 15 seconds). If the cover is opened, observe that the Status LED (ST) changes from quick flashing red to flashing red/yellow.
2. Set the Forward-Stop-Reverse Switch, if installed, to the "STOP" position and then to the desired direction setting.

---

## **14 DIAGNOSTIC INDICATORS**

---

The drive contains an illuminated On/Off AC Line Switch and two diagnostic LEDs to display the drive's operational status. See Figure 2, on page 8, for the location of the "PWR" and "ST" LEDs.

**Note:** *The drive is factory set to the Automatic Start Mode. For Manual Start/Reset Mode, see Section 7.3.2, on page 22.*

## 14.1 ILLUMINATED ON/OFF AC LINE SWITCH

The On/Off AC Line Switch will illuminate when the AC line is applied to the drive and the switch is in the ON ("I") position.

## 14.2 POWER ON LED (PWR)

The "PWR" LED, located on the drive's PC board, will illuminate green when the AC line is applied to the drive and the On/Off AC Line Switch is set to the on ("I") position.

## 14.3 STATUS LED (ST)

The "ST" LED, located on the drive's PC board, is a tricolor LED which provides indication of a fault or abnormal condition. The information provided can be used to diagnose an installation problem such as incorrect input voltage, overload condition, and drive output miswiring. It also provides a signal which informs the user that all drive and microcontroller operating parameters are normal. Table 7, summarizes the "ST" LED functions.

**TABLE 7**  
**OPERATING CONDITION AND STATUS LED INDICATOR**

Operating Condition	Status LED	
	Flash Rate <sup>1</sup>	Color
Normal Operation	Slow	Green
Overload (120% - 160% Full Load)	Steady	Red <sup>2</sup>
Overload Trip (Drive Timed Out)	Quick	Red <sup>2</sup>
Short Circuit	Slow	Red
Undervoltage	Quick	Red/Yellow
Undervoltage Recovery <sup>3</sup>	Quick	Red/Yellow/Green
Overvoltage	Slow	Red/Yellow
Overvoltage Recovery <sup>3</sup>	Slow	Red/Yellow/Green
Stop	Steady	Yellow

**Notes:** 1. Slow Flash = 1 second on and 1 second off. Quick Flash = 0.25 second on and 0.25 second off. 2. In Manual Start Mode, when the Overload is removed, before the  $I^2t$  times out and trips the drive, the Status LED will flash green. 3. In Manual Start Mode, when the Undervoltage or Overvoltage condition is corrected, the Status LED will flash Red/Yellow/Green.



### **LIMITED WARRANTY**

For a period of 18 months from the date of original purchase, KB Electronics, Inc. will repair or replace without charge, devices which our examination proves to be defective in material or workmanship. This warranty is valid if the unit has not been tampered with by unauthorized persons, misused, abused, or improperly installed, and has been used in accordance with the instructions and/or ratings supplied. The foregoing is in lieu of any other warranty or guarantee, expressed or implied. KB Electronics, Inc. is not responsible for any expense, including installation and removal, inconvenience, or consequential damage, including injury to any person, caused by items of our manufacture or sale. Some states do not allow certain exclusions or limitations found in this warranty and therefore they may not apply to you. In any event, the total liability of KB Electronics, Inc., under any circumstance, shall not exceed the full purchase price of this product. (rev. 2/2002)

### **COPYRIGHT © 2014 KB Electronics, Inc.**

All rights reserved. In accordance with the United States Copyright Act of 1976, no part of this publication may be reproduced in any form or by any means without permission in writing from KB Electronics, Inc. (8/2002)

**The information contained in this manual is intended to be accurate.  
However, the manufacturer retains the right to make changes in design,  
which may not be included herein.**



**KB Electronics, Inc.**

12095 NW 39 Street, Coral Springs, FL 33065-2516

Phone: 954-346-4900; Fax: 954-346-3377

Outside Florida call Toll Free: 800-221-6570

E-Mail: [info@kbelectronics.com](mailto:info@kbelectronics.com)

[www.kbelectronics.com](http://www.kbelectronics.com)